



SILICONE NEON STRIP

PRODUCT SPECIFICATION

RLLNFSB0817 Side Bend



- It is made of Dow Chemical SILASTIC™ ET 7021 silicone rubber, which provides high transparency and high strength;
- Environmental protection grade silicone material, integrated extrusion molding process;
- Unique optical light distribution structure design, uniform lighting surface and no shadow;
- IP67 protection level, salt solution resistance, acids & alkalis and UV resistance;
- Excellent toughness, simple and stylish appearance, delicate and unique;
- 3 years warranty, working life \geq 30000 hours.

Dimension structure

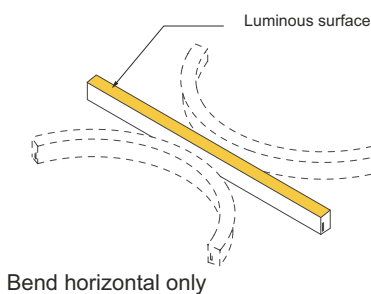
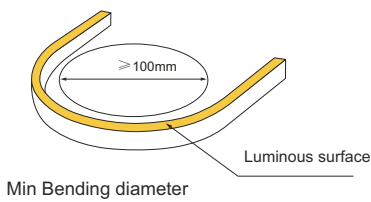
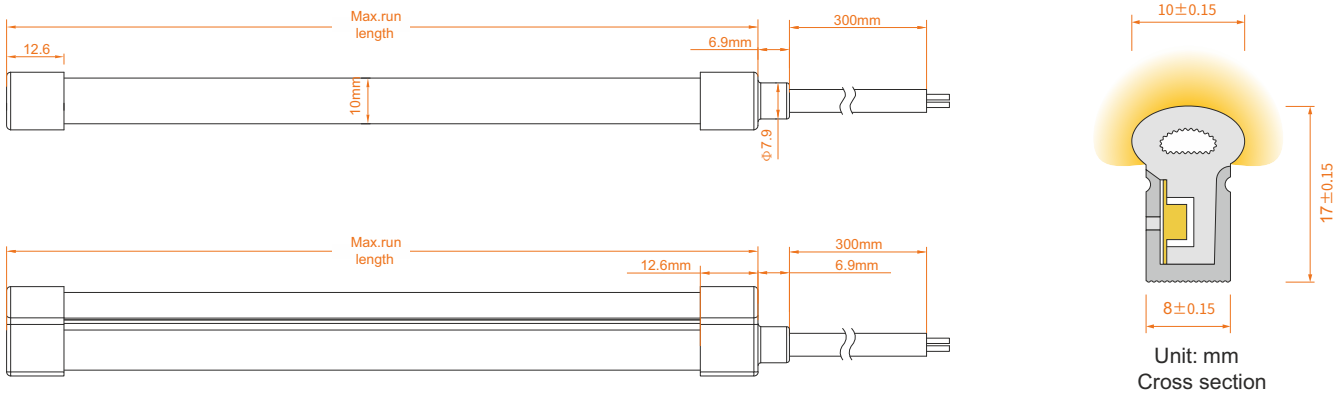

Electrical Parameter

Voltage	LED PIN Temperature	Storage Temperature	Ambient Temperature	CRI
DC24V	Max. 65°C	25°C ~ 60°C	Min. 25°C Max(Table below)	\geq 90

Specification

Power(w/m)	Efficacy(lm/w)@4000K	Max Ambient Temperature
5 w/m	34.8lm/w	55°C
10 w/m	34lm/w	45°C

Due to the tolerance of the production and electrical components, output value and electrical power can vary up to 10%

Length Standard

Length Range (M)	Final Length	Tolerance(mm)
0M<Neon Strip(L)≤5M	L+8	±7
5M<Neon Strip(L)≤10M	L+8	±10
10M<Neon Strip(L)≤15M	L+8	±13
15M<Neon Strip(L)≤20M	L+8	±16
20M<Neon Strip(L)≤25M	L+8	±19



- The maximum series length refers to the maximum single end power supply length of the constant current strip under the condition of standard 30cm wire .
- The given color temperature is the temperature of finished product.
- The given data are typical values due to the tolerances of the production process and the electrical components, values for light output and electrical power can vary up to 10%.
- All products can be dimmed; the dimmer' s voltage should conform to the rated voltage of the led light. The output frequency of the dimmer of the constant-current led light should be less than 2K Hz, and the output PWM can control the led light.

Single color (Lm/m)

CCT(K)	CRI	Voltage	Power(W)	Lumen (LM/M)	Efficiency (LM/W)	Unit Length (mm)	Max. Run Length (M)	CC/CV
2100K±150	≥90	DC24V	10	270	27	50	1\$CC)	CC/CV
2400K±150	≥90	DC24V	10	285	28.5	50	1\$CC)	CC/CV
2700K±150	≥90	DC24V	10	310	31	50	1\$CC)	CC/CV
3000K±150	≥90	DC24V	10	310	31	50	1\$CC)	CC/CV
3500K±200	≥90	DC24V	10	320	32	50	1\$CC)	CC/CV
4000K ⁺⁴⁰⁰ ₋₂₀₀	≥90	DC24V	10	340	34	50	1\$CC)	CC/CV
5000K ⁺⁵⁰⁰ ₋₃₀₀	≥90	DC24V	10	345	34.5	50	1\$CC)	CC/CV
6500K ⁺²⁰⁰ ₋₆₀₀	≥90	DC24V	10	320	32	50	1\$CC)	CC/CV
Red	--	DC24V	10	150	15	50	1\$CC)	CC/CV
Green	--	DC24V	10	360	36	50	1\$CC)	CC/CV
Blue	--	DC24V	10	70	7	50	1\$CC)	CC/CV
Yellow	--	DC24V	10	120	12	50	1\$CC)	CC/CV
Pink	--	DC24V	10	150	15	50	1\$CC)	CC/CV







CCT Tunable (Lm/m)

CCT(K)	CRI	Voltage	Power(W)	Lumen (LM/M)	Efficiency (LM/W)	Unit Length (mm)	Max. Run Length (M)	CC/CV
WW	≥90	DC24V	5	170	34	50	5	CV
W	≥90	DC24V	5	172.5	34.5	50	5	CV
W+WW	≥90	DC24V	10	330	33	50	5	CV

RGB (Lm/m)

CCT(K)	CRI	Voltage	Power(W)	Lumen (LM/M)	Efficiency (LM/W)	Unit Length (mm)	Max. Run Length (M)	CC/CV
R	--	DC24V	3.3	36.3	11	62.5	5	CV
G	--	DC24V	3.3	92.4	28	62.5	5	CV
B	--	DC24V	3.3	16.5	5	62.5	5	CV
RGB	--	DC24V	10	145	14.5	62.5	5	CV

Cable Type

Cable Type	Schematic Diagram	Specification	Core	Electrical Properties
PVC Cable		OD: 5.0mm / Inner core: 20AWG	● ●	Red V+ Black V
		OD: 5.0mm / Inner core: 20AWG	● ○ ●	Brown V+ White W Yellow WW
		OD: 5.5mm / Inner core: 20AWG	● ● ● ●	Black V+ Blue B Green G Red R
Waterproof Connector with PVC Cable		OD: 5.0mm / Inner core: 20AWG M12Male / Female connecto	● ●	Red V+ Black V
		OD: 5.0mm / Inner core: 20AWG M12Male / Female connecto	● ○ ●	Brown V+ White W Yellow WW
		OD: 5.5mm / Inner core: 20AWG M12Male / Female connecto	● ● ● ●	Black V+ Blue B Green G Red R

Cutting Mark

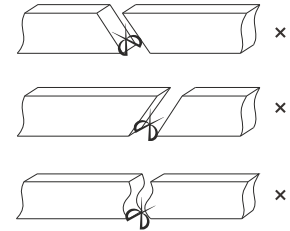

Remark:
The bottom of the led strip has transparent window to cut vertically at the cutting mark the black marker is the cutting position

Use professional scissors

Please don't be feel free to cut and cut into an oblique angle or cambered section.

Mounting Way



Aluminium mounting clips
20x10.6x14mm(L x W x H)
Accessories:
Screw M3x15mm

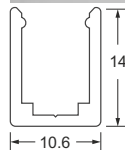

Aluminium profile
1000(±5)x10.6x14mm(L x W x H)
Accessories:
Screw M3x15mm

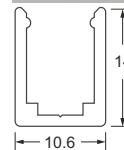

Single Color Connection Diagram

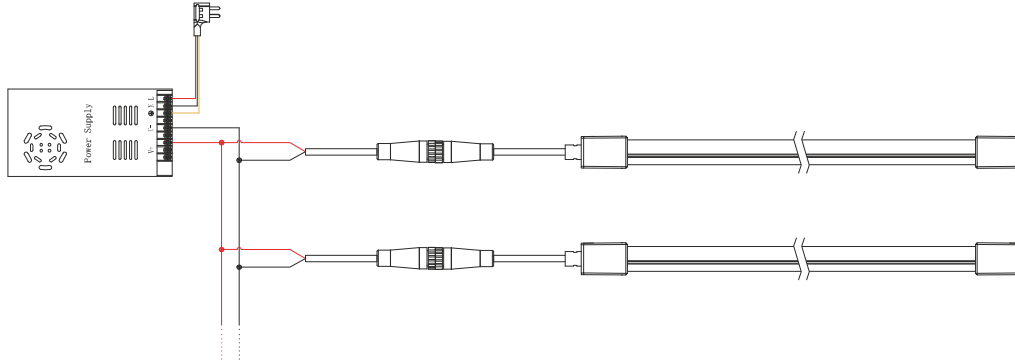

Tunable white Connection Diagram

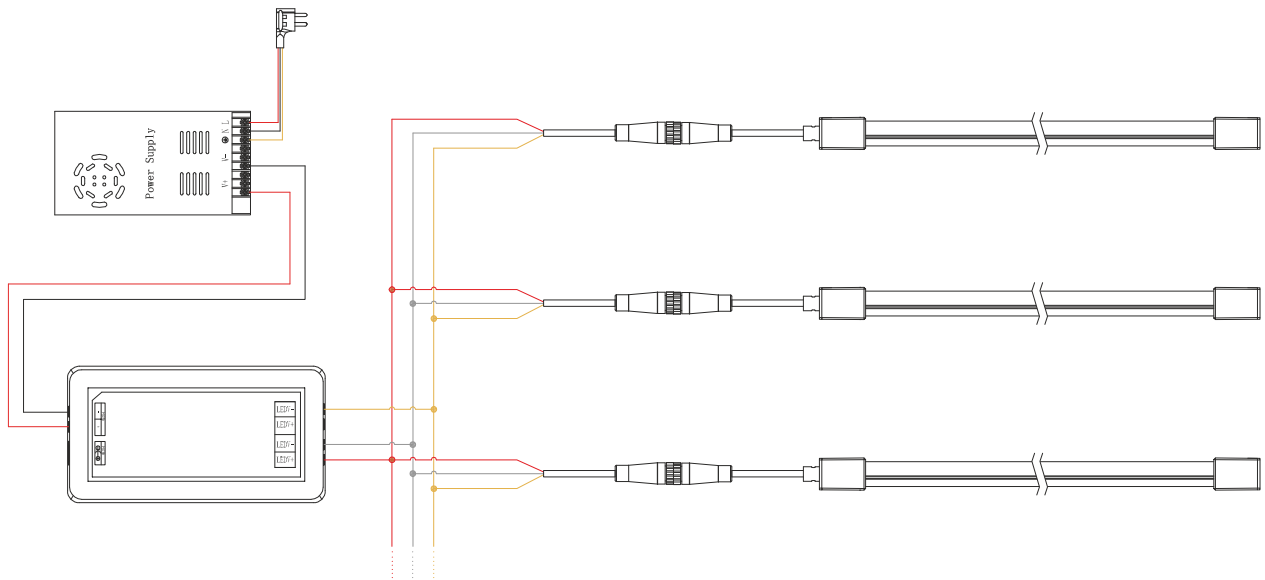

RGB Connection Diagram

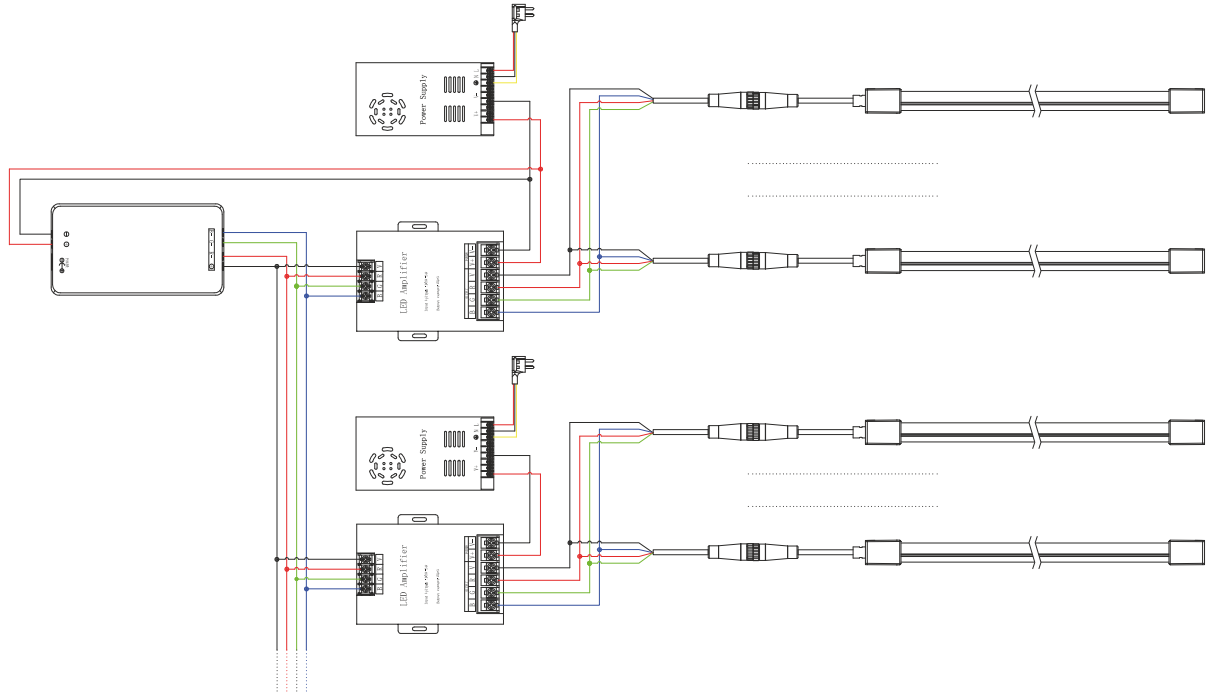

Installation Precautions

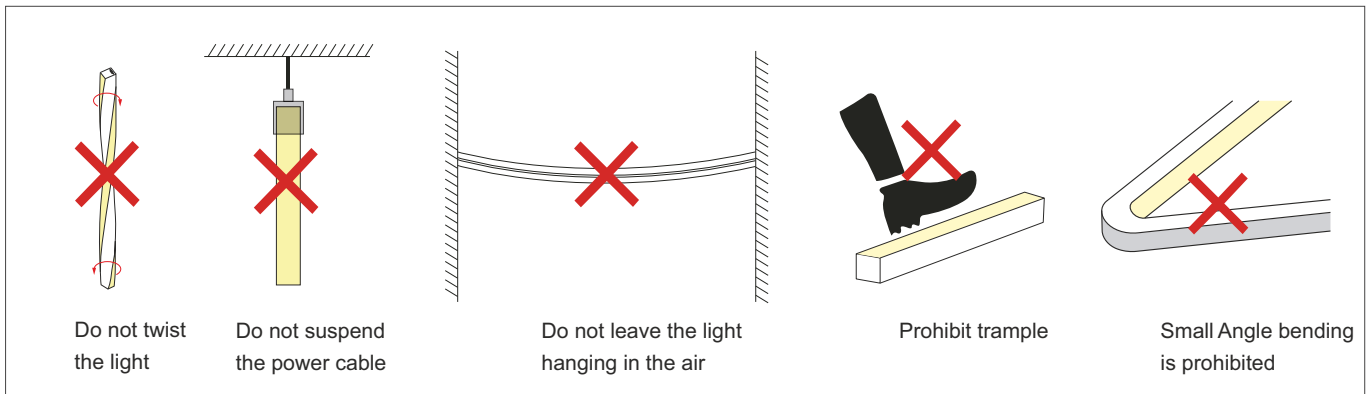
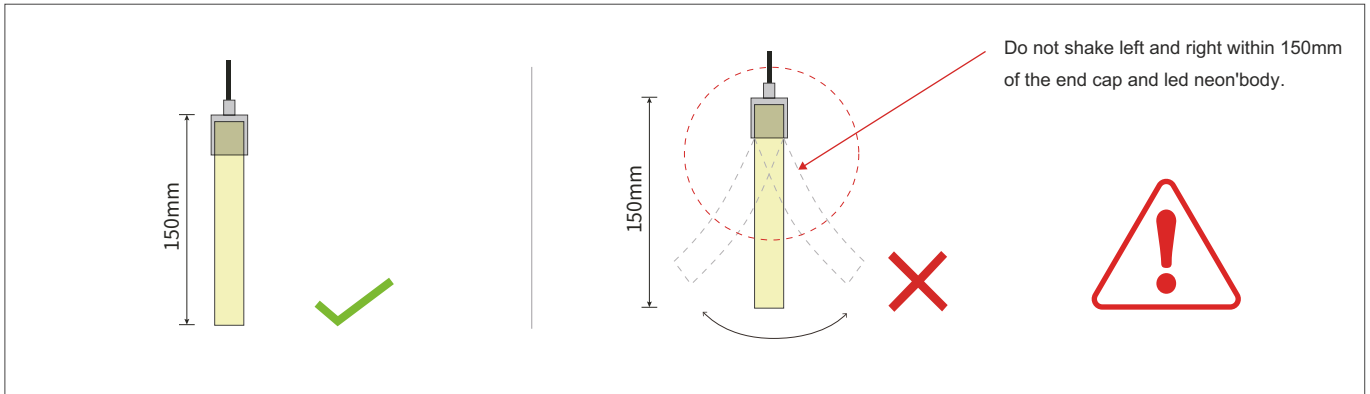

Put it in the profile

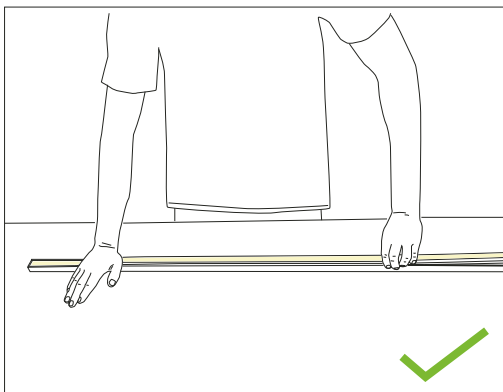

Please press the led strip with your palm to slowly insert the led strip into the groove, and gently straighten the led strip above the groove with your right hand.
Try to keep the led strip in a flat state during the installation process.

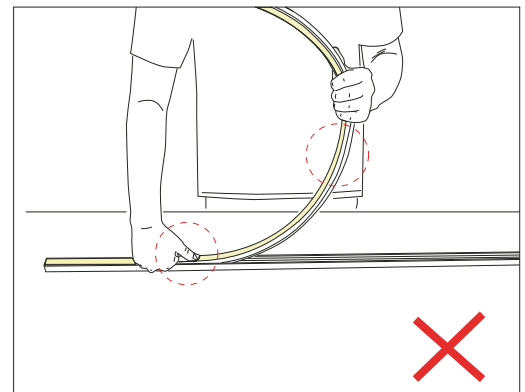

Do not press the led strip with a single finger, it is easy to damage the internal parts of the led strip.
The bent arc of the led strip should not be too large during installation.

Installation Precautions - Side Mounted (If the length of the light is more than 2 meters, two persons must work together to install it.)

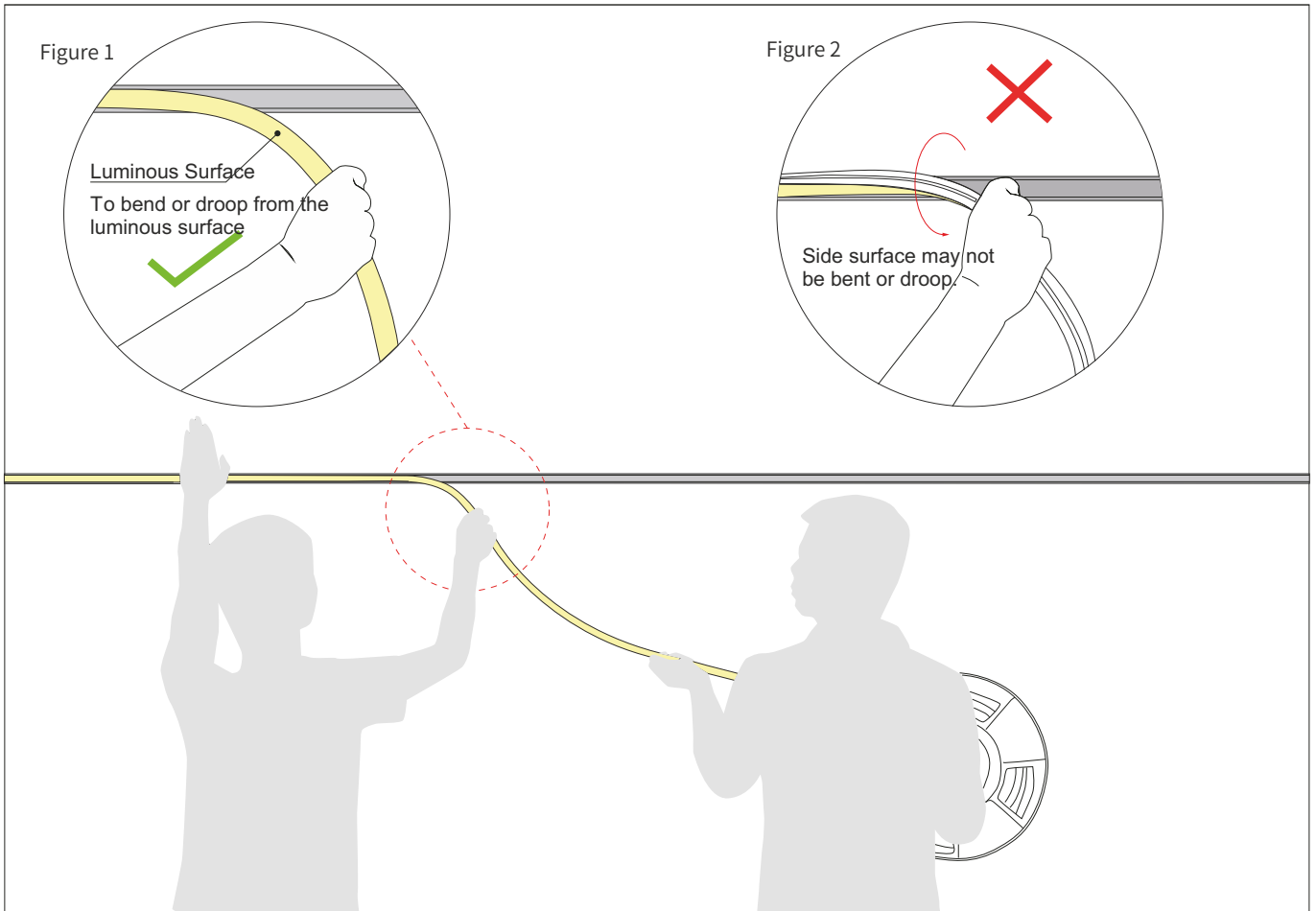

1. Installer:

Press the light with the palm of the left hand to slowly load it into the slot. Straighten the light with right hand so that it droop it in the direction of your hand. See Figure 1.

Side surface may not be bent or droop, See Figure 2.

2. Assistant:

Cooperate with the installer to lift the reel of the light, and then slowly deliver the light to installer. Do not pull or twist the light during the installation.

Installation Precautions - Side Mounted (If the length of the light is more than 5 meters, two persons must work together to install it.)

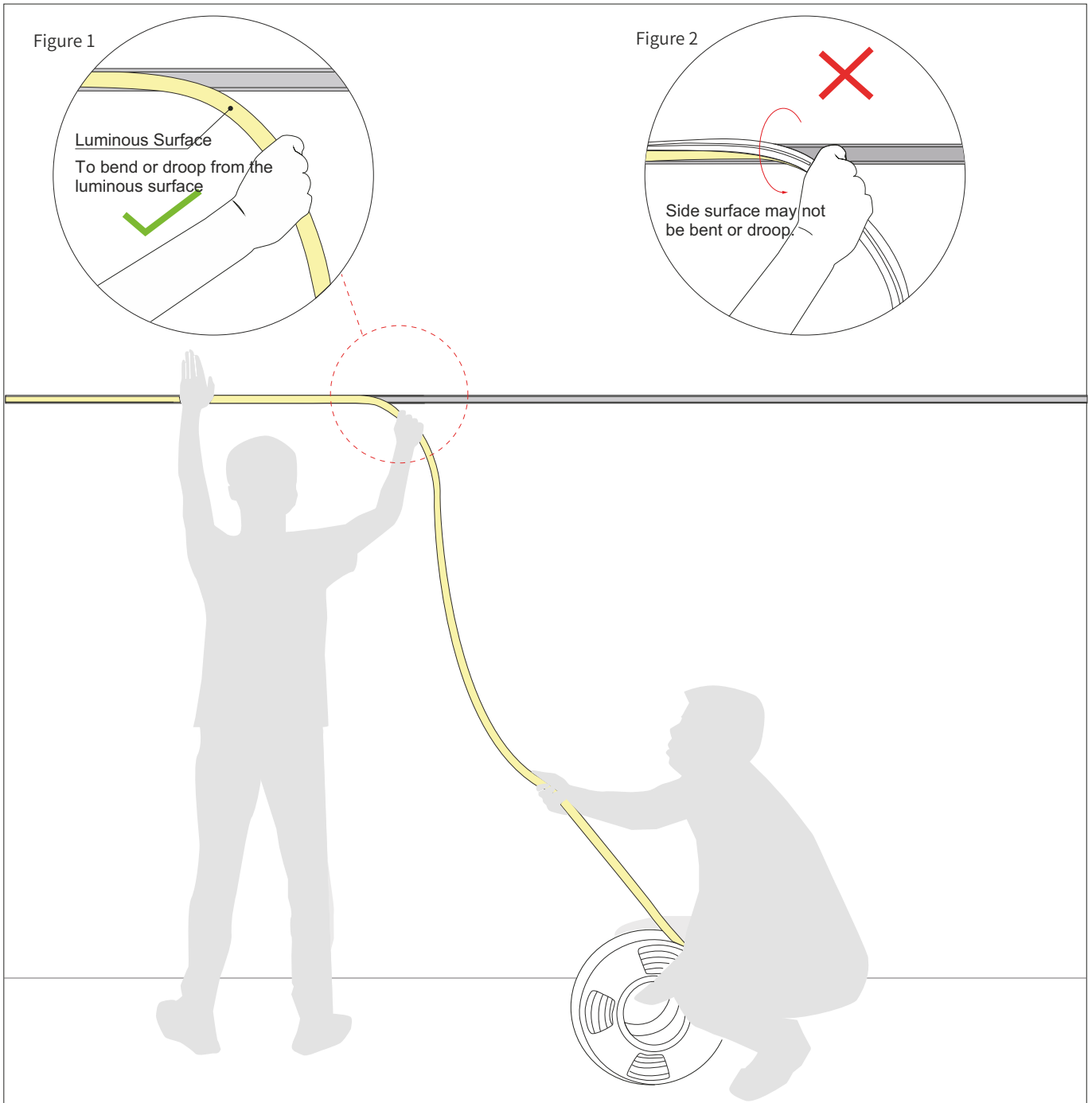

1.Installer:

Press the light with the palm of the left hand to slowly load it into the slot. Straighten the light with right hand so that it droop in the direction of your hand. See Figure 1.

2.Assistant:

Cooperate with the installer to slowly deliver the light to installer. Do not pull or twist the light during the installation.

Installation Precautions - Top Mounted (If the length of the light is more than 2 meters, two persons must work together to install it.)

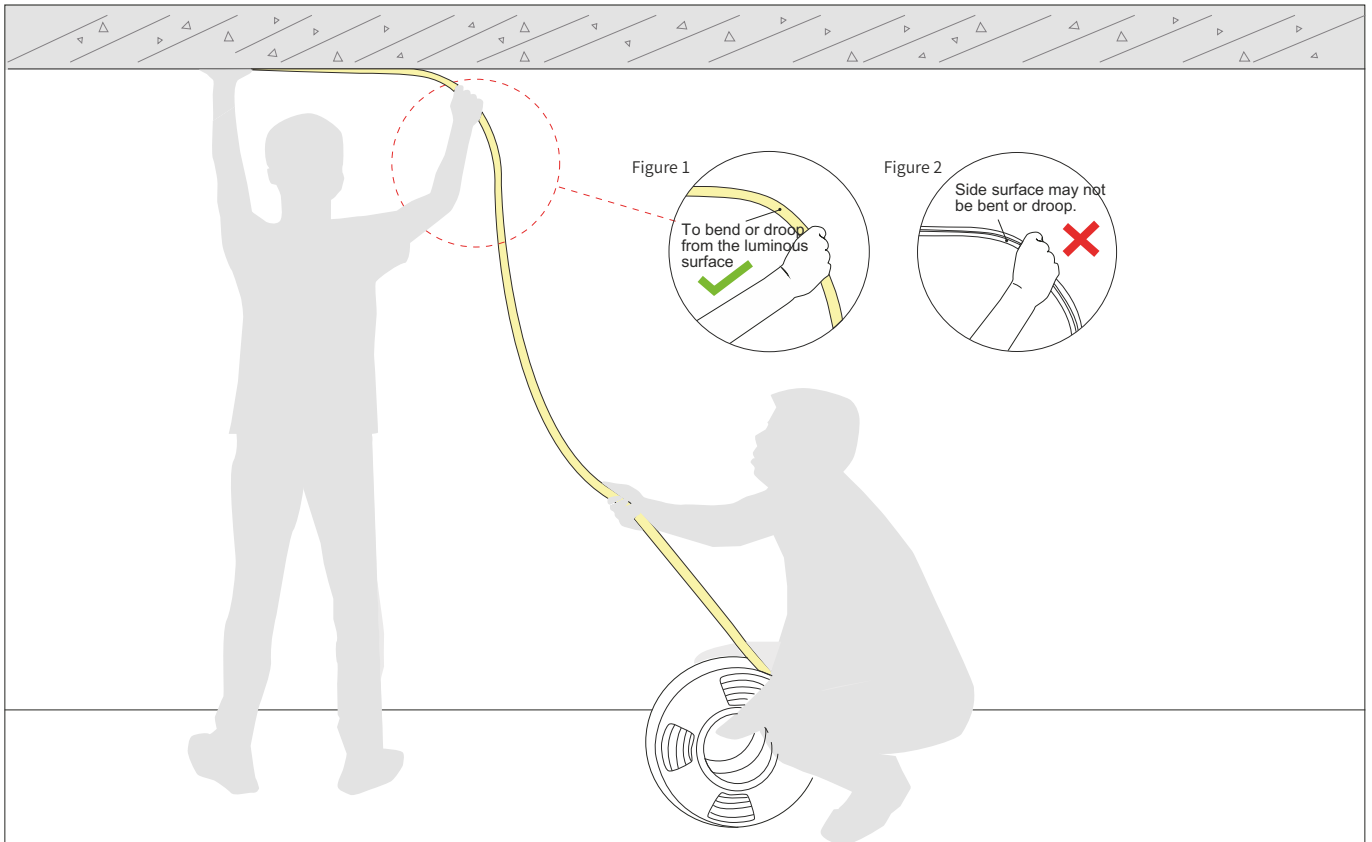

1. Installer:

Press the light with the palm of the left hand to slowly load it into the slot. Straighten the light with right hand, hold it and rotate it 90° to droop it in the direction of your hand. See Figure 1. Side surface may not be bent or droop, See Figure 2.

2. Assistant:

Cooperate with the installer to slowly deliver the light to installer. Do not pull or twist the light during the installation.

Notes

The selection of the cable specification at the output end of the power supply, it depends on the total current of the load and the length of the cable. It is recommended to select according to the following table:

Current of the light	Specifications of the cable								
	L=1M	L=2M	L=4M	L=6M	L=8M	L=10M	L=12M	L=14M	L=16M
1A	AWG26	AWG23	AWG21	AWG18	AWG18	AWG17	AWG16	AWG15	AWG15
2A	AWG23	AWG21	AWG18	AWG16	AWG15	AWG14	AWG13	AWG12	AWG12
3A	AWG22	AWG18	AWG16	AWG14	AWG13	AWG12	AWG11	AWG11	AWG10
4A	AWG21	AWG18	AWG15	AWG13	AWG12	AWG11	AWG10	AWG9	AWG9
5A	AWG20	AWG17	AWG14	AWG12	AWG11	AWG10	AWG9	AWG9	AWG8
6A	AWG18	AWG16	AWG13	AWG11	AWG10	AWG9	AWG8	AWG8	AWG7
7A	AWG18	AWG15	AWG12	AWG11	AWG9	AWG8	AWG8	AWG7	AWG6
8A	AWG17	AWG15	AWG12	AWG10	AWG9	AWG8	AWG7	AWG7	AWG6
9A	AWG17	AWG14	AWG11	AWG10	AWG8	AWG7	AWG7	AWG6	AWG5
10A	AWG16	AWG14	AWG11	AWG9	AWG8	AWG7	AWG6	AWG6	AWG5

- The unused light should be sealed with the packaging bag to avoid prolonged exposure.
- Please use DC24V isolated constant voltage power supply with ripple voltage less than 5%. Using other types of power supply may damage the light or cause other safety risks.
- In practical application, 20% allowance should be reserved for power supply to ensure the stability of power supply.
- It is recommended that professionals connect the power supply. Do not connect the power supply with live power to avoid electric shock.
- Please confirm whether the voltage of the power supply is consistent with the voltage of the light; Pay attention to the positive and negative poles of the power cord, do not connect wrong, so as not to cause product damage;
- When multiple power supplies are used, ensure that the positive poles of the power supply are not connected in parallel. Otherwise, the power supply system may be unstable or damaged after long-term operation.
- If the actual application length exceeds the specified length, it will lead to overload, heating and uneven brightness of the light.
- During installation, please do not scratch, twist or bend the light irregularly. Otherwise, the light may be damaged beyond repair.
- To ensure the life and reliability of the light, please do not over bend the light, which will damage the product itself.
- To protect your eyes, please avoid staring at the glowing surface of the light for a long time.
- Non professionals are forbidden to install, disassemble and maintain the product.
- Do not use any acid or alkaline adhesive to fix the light (including but not limited to glass glue, etc.)
- IP67 products are not suitable for long-term immersion in water; IP68 products are only customized by the factory. After cutting and processing by users themselves, there is a risk that IP68 protection level cannot be reached
- Because of the difference in structure, even if the same color temperature value, different sizes of light will look slightly different colors. Please confirm it before use.

Tests showed that methanol and benzenes will have yellowing effects on silicone.

In the newly decorated interior environment, epoxy floor paint, wall paint, wallpaper adhesive, various decoration materials or new furniture, they are likely to release of methanol and benzenes.

It is recommended to remove methanol and benzenes first, or ventilate for a period of time in the newly decorated interior environment before install the silicone neon light, to avoid affecting the silicone body.