

RHEA TOP

- » Cross section of 16x15mm
- » Full PU encapsulation, Waterproof IP68
- » Lighting Efficiency: up to 110lm/W
- » Perfect softness, gentle emitting, No dazzling
- » DMX RGB/RGBW
- » SPI RGB/RGBW
- » ETL, CE, RoHS, EMC, FCC, IP68 Certificate
- » Working Environment: -25°C-65°C
- » Warranty: 3-5 years



Waterproof
IP68



UV
Protected



Saltwater
Resistant



Solvent
Resistant



IK08
Protection



3 steps
LED



LM-80
Compliant

Dimension

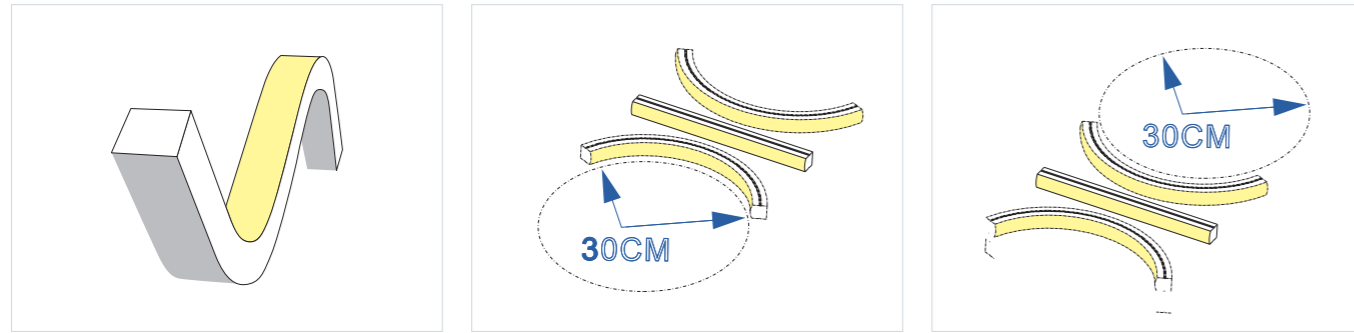
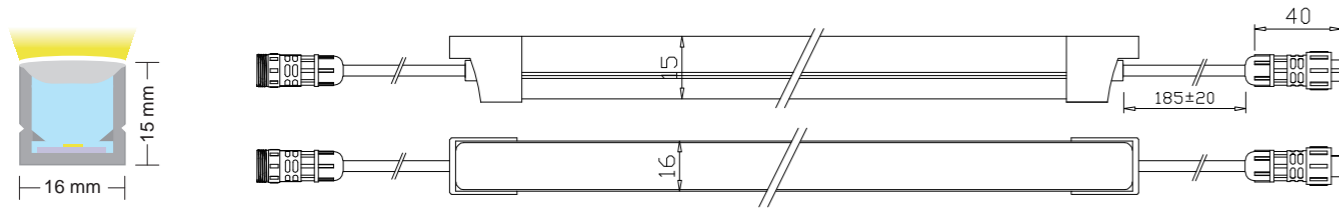

Various Cable Entry

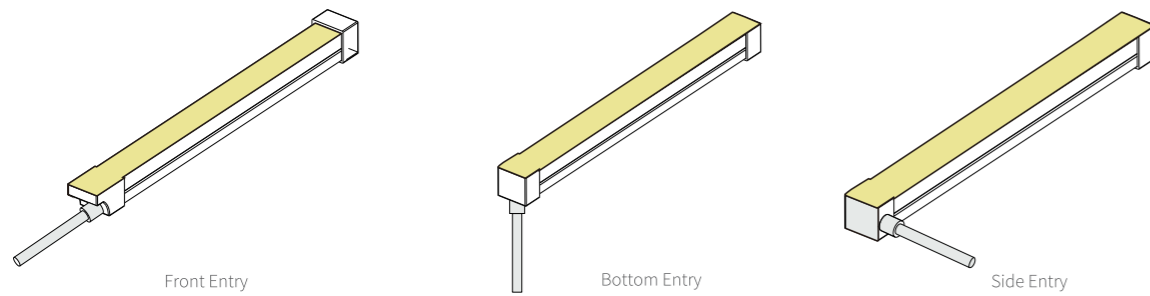

Seamless Connection



Light Distribution

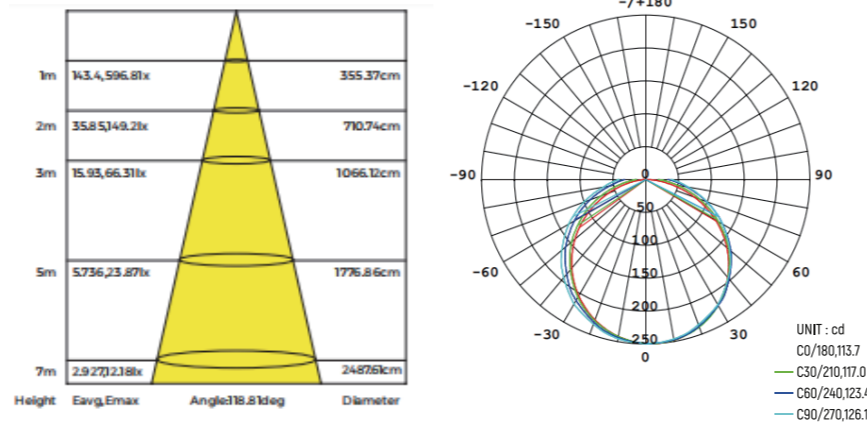

RHEA TOP SINGLE COLOR

- ▶ High efficiency, up to 110lm/W
- ▶ Color consistency, One bin, 3 SDCM
- ▶ Input voltage 12VDC/24VDC optional
- ▶ CV for Constant Voltage, CC for Constant Current

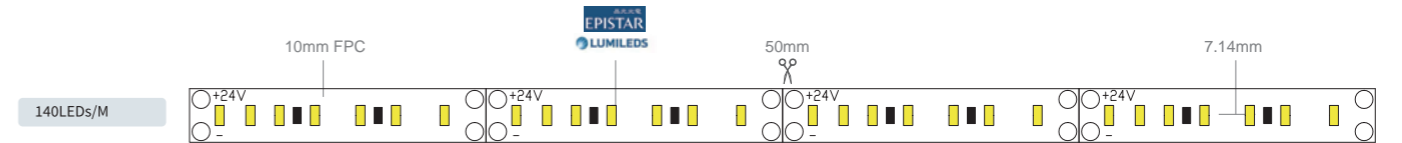

Electrical Data

Electrical solution	LED Type	LEDs/Mtr	Voltage	Max Current	Max run (Single end)	Cutting unit	IP Rating
Constant Voltage	SMD3014	140	DC 24V	0.416A/M	10m	50mm/ 7LEDs	IP68
Constant Voltage	SMD3014	144	DC 12V	0.833A/M	10m	25mm/ 6LEDs	IP68
Constant Current	SMD3014	120	DC 24V	0.416A/M	10m	50mm/ 6LEDs	IP68
Constant Current	SMD2835	96	DC 24V	0.291A/M	25m	41.6mm/ 4LEDs	IP68

Spectrum Data

Item No.	LED Code No.	CC/CV	Wattage	Lumen Efficiency	Lumen	Beam Angle	Color	CRI
RLLTNFJ27C		CV	10W/M	95lm/W	950lm/M	120°	2700K	80+/90+
RLLTNFJ30C		CV	10W/M	105lm/W	1050lm/M	120°	3000K	80+/90+
RLLTNFJ40C	2J-3014 140Leds/m (DC24V)	CV	10W/M	107lm/W	1070lm/M	120°	4000K	80+/90+
RLLTNFJ60C	2K-3014 144Leds/m (DC12V)	CV	10W/M	109lm/W	1090lm/M	120°	6000K	80+/90+
RLLTNFJ04C		CV	10W/M	-	260lm/M	120°	R	-
RLLTNFJ06C	B for DC12V	CV	10W/M	-	360lm/M	120°	G	-
RLLTNFJ05C	C for DC24V	CV	10W/M	-	193lm/M	120°	B	-
RLLTNFJ07C		CV	10W/M	-	600lm/M	120°	Y	-
RLLTNFJ09C		CV	10W/M	-	280lm/M	120°	W	-
RLLTNFJ27C		CC	10W/M	60lm/W	600lm/M	120°	2700K	80+
RLLTNFJ30C		CC	10W/M	62lm/W	620lm/M	120°	3000K	80+
RLLTNFJ40C	2i-3014 120Leds/m (DC24V)	CC	10W/M	65lm/W	650lm/M	120°	4000K	80+
RLLTNFJ60C		CC	10W/M	68lm/W	680lm/M	120°	6000K	80+
NEW RLLTNFH27C		CC	7W/M	45.7lm/W	320lm/M	120°	4000K	80+
NEW RLLTNFH30C		CC	7W/M	50.1lm/W	350lm/M	120°	3000K	80+
NEW RLLTNFH40C	1H-2835 96Leds/m	CC	7W/M	52.8lm/W	370lm/M	120°	6000K	80+
NEW RLLTNFH60C		CC	7W/M	57.1lm/W	400lm/M	120°	3000K	80+

RHEA TOP PIXEL RGB/RGBW/WHITE

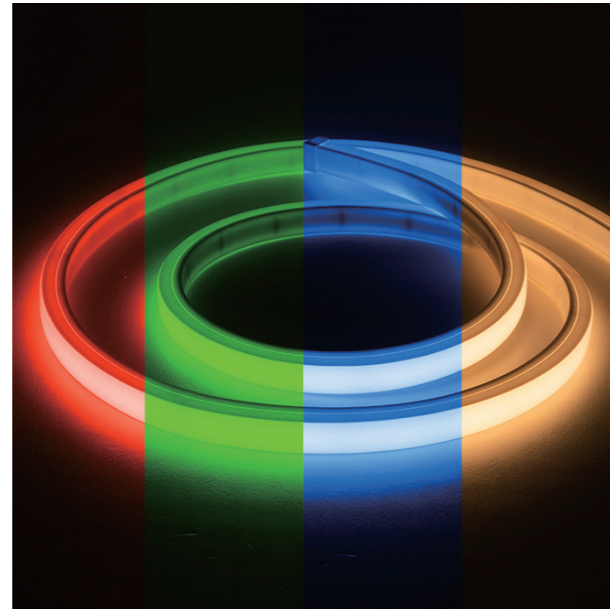

- ▶ RGB/RGBW/White chasing magic color changing
- ▶ SPI and DMX IC solution optional
- ▶ Epistar SMD5050 RGB 3 in 1 LED, SMD5050 RGBW 4 in 1 LED
- ▶ Epistar SMD2835 for White chasing design

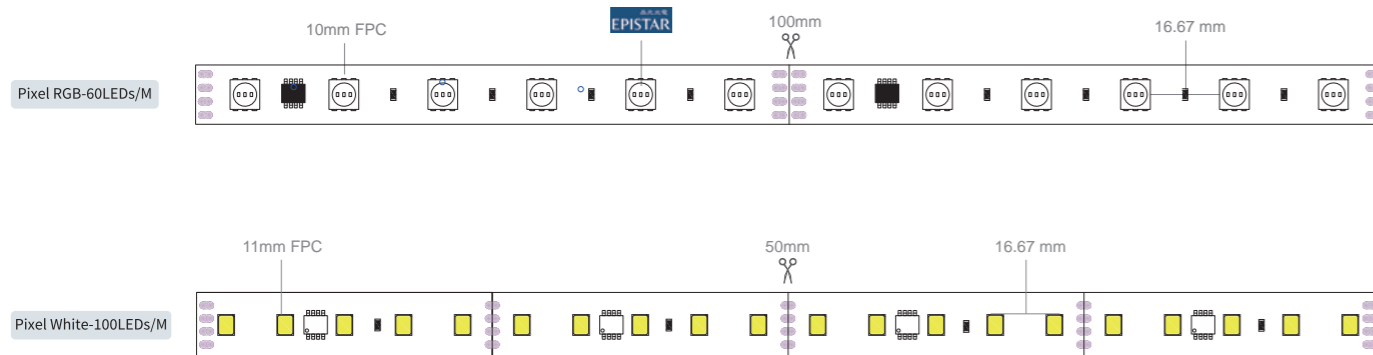

Electrical Data

Electrical solution	LED Type	LEDs/Mtr	Voltage	Max Current	Max run (Single end)	Cutting unit	IP Rating	Color
Constant Voltage	SMD2835	98	DC 24V	0.916A/M	5m	71.4mm/ 7LEDs	IP68	RGB
Constant Voltage	SMD5050	70	DC 24V	0.541A/M	5m	100mm/ 7LEDs	IP68	RGB
Constant Voltage	SMD5050	60	DC 24V	0.541A/M	5m	100mm/ 7LEDs	IP68	RGBW
Constant Voltage	SMD5050	70	DC 24V	0.583A/M	5m	100mm/ 7LEDs	IP68	RGBW
Constant Voltage	SMD5050	60	DC 24V	0.586A/M	5m	100mm/ 7LEDs	IP68	White
Constant Voltage	SMD2835	100	DC 24V	0.541A/M	5m	50mm/ 5LEDs	IP68	White

Spectrum Data

Item No.	Wattage	IC Type	Lumen	Beam Angle	Color	CRI
RLLTNFW02C (Pixel RGB-5 wires)	22W/M	DMX TM512AC	536lm/M	120°	RGB	-
RLLTNFF02C (Pixel RGB-3 wires)	1W-2835 98Leds/m	SPI 2811	450lm/M	120°	RGB	-
RLLTNFE02C (Pixel RGB-4 wires)	4F-5050 70Leds/m	DMX UCS512B3	380lm/M	120°	RGBW	-
RLLTNFF02C (Pixel RGBW-3 wires)	4E-5050 60Leds/m	SPI 2904	600lm/M	120°	RGBW	-
RLLTNFE02C (Pixel RGBW-4 wires)	1W-2835 100Leds/m	DMX UCS512B4L	650lm/M	120°	RGBW	-
NEW RLLTNFW30C (White Chasing-4 wires)	13W/M	DMX UCS512B3	590lm/M	120°	White	80+

ACCESSORIES

RHEA TOP

Mounting Profile

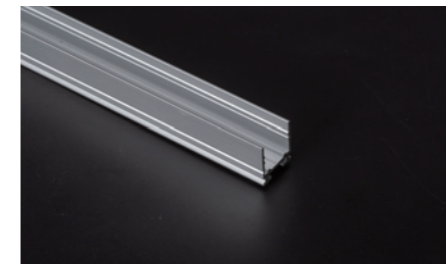

Aluminum Profile
Item No.: JA0049
Dimension(LxWxH): 1000x19x21.5mm
Material: Aluminum



Aluminum Profile (Outlet)
Item No.: JA0105
Dimension (LxWxH): 1000x21x41.5mm
Material: Aluminum



Stainless Flexible Profile
Item No.: JK0021
Dimension (LxWxH): 970x16x16.3mm
Material: SUS304\SUS316

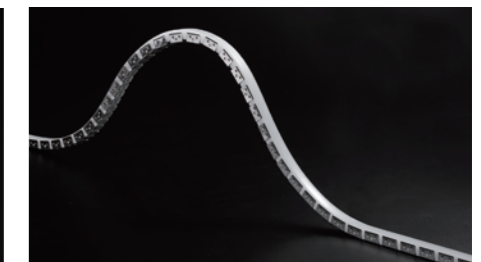
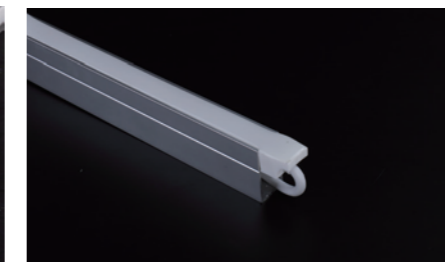
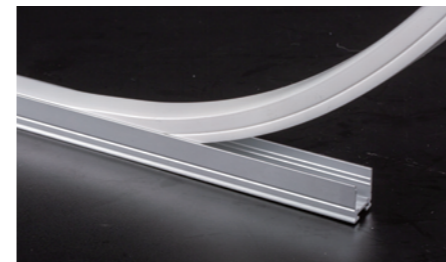

Mounting Clips



Stainless Clips
Item No.: JK0015
Dimension(LxWxH): 15 X 17 X 8.8mm
Material : SUS304\SUS316

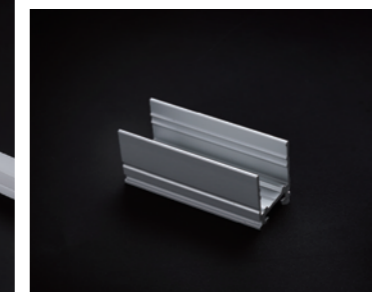

Aluminum Clips
Item No.: JA0049
Dimension(LxWxH): 30X19X21.5mm
50X19X21.5mm
Material: Aluminum 6063

Cutting Tool

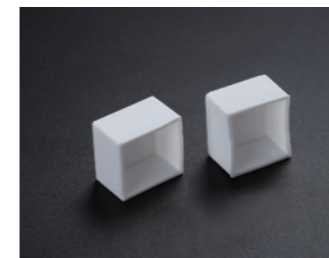

End Cap
Item No.: JD0010
Dimension(LxWxH): 19X18X12mm
Material: Silicone



Scissors
Item No.: GJ0051











Glue
Item No.: JS0012
Dimension: 45g/pcs



ACCESSORIES

RHEA TOP

Waterproof Connector

Image	Item No.	Pin /Way	Connector
	C-PL02-A C-PL03-D C-PL04-M	2 Pin 3 Pin 4 Pin	IP65 Waterproof M/F Connector -M10 20cm Cable White Waterproof M/F connectors
	DX0369 DX0368 DX0367 DX0370	2 Way 3 Way 4 Way 5 Way	IP65 Waterproof Splitter M10-05 2Pin Splitter
	DX0422 DX0423 DX0424 DX0425	2 Pin 3 Pin 4 Pin 5 Pin	IP67 Waterproof Jumper -M15 20cm Cable White Waterproof M/F connectors
	C-PL02-W C-PL03-C C-PL04-L C-PL05-C	2 Pin 3 Pin 4 Pin 5 Pin	IP67 Waterproof M/F Connector -M12 20cm Cable Black Waterproof M/F connectors
	C-PL02-P C-PL03-A C-PL04-G C-PL05-A	2 Pin 3 Pin 4 Pin 5 Pin	IP67 Waterproof M/F Connector -M15 20cm Cable White Waterproof UL M/F connectors
	C-PL02-Q C-PL03-B C-PL04-H C-PL06-A	2 Pin 3 Pin 4 Pin 6 Pin	IP67 Waterproof JST Connector 20cm Cable JST connectors
	DX0286 DX0403 DX0290 DX0329	2 Pin 3 Pin 4 Pin 5 Pin	IP68 Waterproof Connector
	DX0392 DX0420 DX0421 DX0390	2 Pin 3 Pin 4 Pin 5 Pin	IP68 T Shape Connector

Controller

Item No	Name	Dimension	Input	Current load	Image
CK0030	Dimmable LED Controller	175 X 44 X 30mm	12-24VDC	20A Max	
CK0031	CCT adjustable LED Controller	175 X 44 X 30mm	12-24VDC	20A Max	
CK0033	RGB LED Controller	175 X 44 X 30mm	12-24VDC	20A Max	
CK0034	RGB Pixel LED Controller	130 X 70 X 25mm	12-24VDC	<2.2A	

Power Supply

Item No	Dimension	IP Rating	Input	Output	Image
CY0023	215 X 115 X 30mm	IP20	90-132VAC/180-264VAC by Switch	24V/14.6A,350W	
CY0042	228 X 68 X 38.8mm	IP67	90-305VAC	24V,0-6.3A,150W	